



the menu company

TECHNICAL SPECIFICATION SHEET FOR FABRIC MENUS

Updated: April 2009

STYLE 1

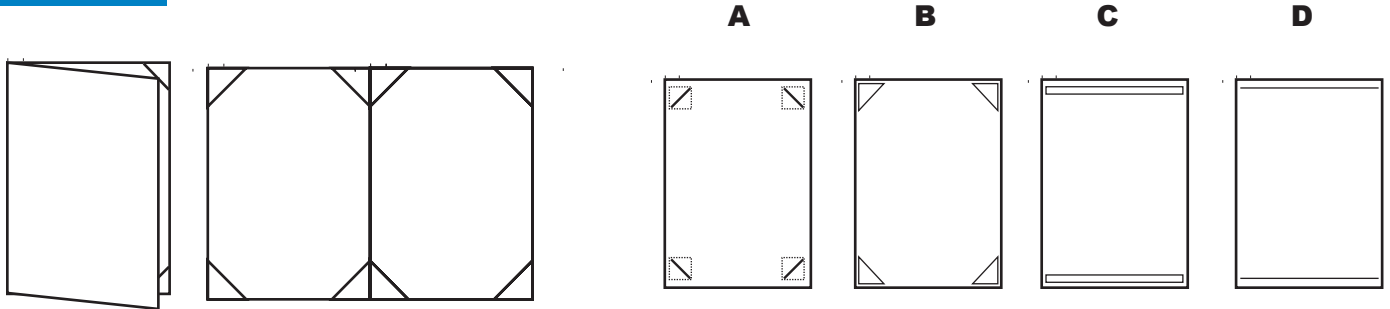

DESCRIPTION	CODE	SIZE (W X H)	PAPER INSERT
SINGLE A4	T105A	240mm X 320mm	1 X A4
SINGLE SLIMLINE	T106A	175mm X 320mm	A4 TRIMMED
DOUBLE A4	T107A	240mm X 320mm	2 X A4
TRIPLE A4	T108A	240mm X 320mm	3 X A4
SINGLE A5	T109E	175mm X 235mm	1 X A5
DOUBLE A5	T109A	175mm X 235mm	2 X A5

OPTIONS:

A. DIE-CUT CORNERS / **B.** HANDMADE CORNERS / **C.** HORIZONTAL STRIPS / **D.** SLITS

STYLE 2

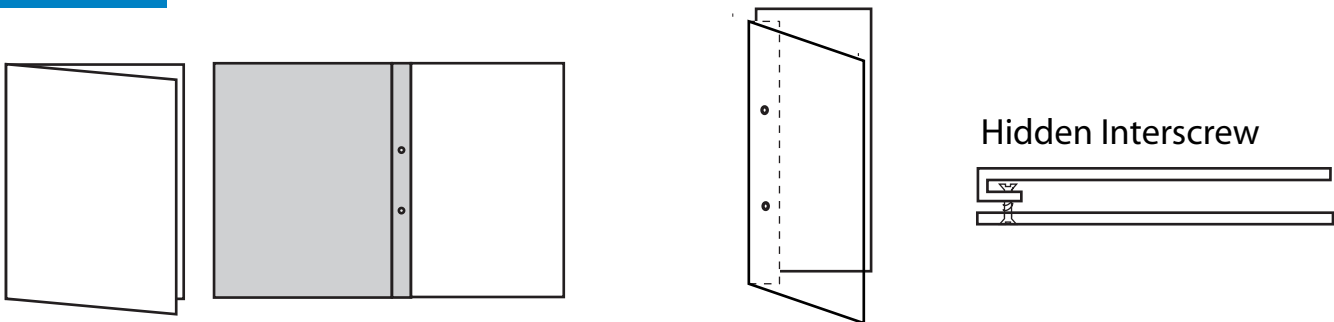

DESCRIPTION	CODE	SIZE (W X H)	PAPER INSERT
A4 HIDDEN INTERSCREW	T110	240(245*)mm X 320mm	Multiple X A4
A5 HIDDEN INTERSCREW	T111	175(180*)mm X 235mm	Multiple X A5
SLIMLINE HIDDEN INTERSCREW-175	T111A	175(180*)mm X 320mm	Multiple X A4 trimmed
SLIMLINE HIDDEN INTERSCREW-150	T111B	150(155*)mm X 320mm	Multiple X A4 trimmed
SQUARE HIDDEN INTERSCREW	T111C	235(240*)mm X 235mm	Multiple X A4 trimmed

* When copysafe sleeves are used with the menu, an extra 5mm is added to the width.



the menu company

TECHNICAL SPECIFICATION SHEET FOR FABRIC MENUS

Updated: April 2009

STYLE 3

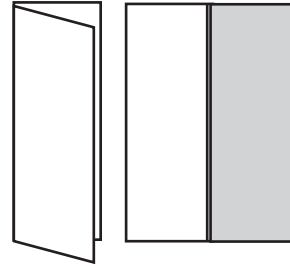
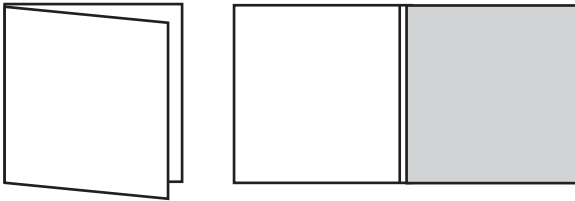

DESCRIPTION	CODE	SIZE (W X H)	PAPER INSERT
POCKET SQUARE	T112	235mm X 235mm	Multiple X A4 folded
POCKET SQUARE- 2 DRILL	T112B	235mm X 235mm	Multiple X A4 folded
POCKET A4	T113	205mm X 320mm	Multiple X A3 folded
POCKET A4 SLIMLINE	T114	150mm X 320mm	Multiple X A4 folded
POCKET A3 SLIMLINE	T114C	205mm X 440mm	Multiple X A3 folded
POCKET A5	T115	175mm X 235mm	Multiple X A4 folded
POCKET COCKTAIL	T118	120mm X 320mm	Multiple X A4 folded

STYLE 4

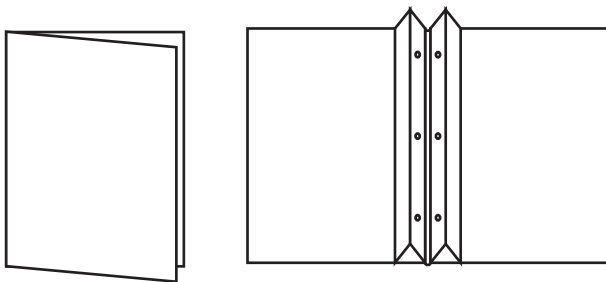

DESCRIPTION	CODE	SIZE (W X Hx Spine)	PAPER INSERT
CENTRE LOCK A4	T116	240mm X 320mm X 15mm	Multiple X A4
CENTRE LOCK SQUARE	T117	235mm X 235mm X 15mm	Multiple X A4 trimmed

* When copysafe sleeves are used with the menu, an extra 5mm needs to be added to the width.



the menu company

TECHNICAL SPECIFICATION SHEET FOR FABRIC MENUS

Updated: April 2009

STYLE 5

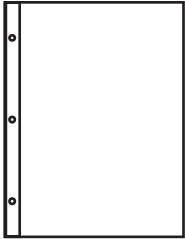

A. STANDARD



B. TWO PIECE -INVERTED HINGE (Eg. T103C)

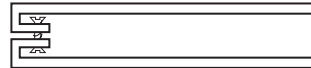

DESCRIPTION	CODE	SIZE (W X H)	PAPER INSERT
TWO PIECE 2 DRILL HINGE A5	T102	175(180*)mm X 235mm	Multiple X A5
TWO PIECE 3 DRILL HINGE A4	T103	240(245*)mm X 320mm	Multiple X A4
ONE PIECE 3 DRILL HINGE A4	T103B	240(245*)mm X 320mm	Multiple X A4
2 PIECE 3 DRILL HINGE A4 SLIMLINE	T104	175(180*)mm X 320mm	Multiple X A4 trimmed
1 PIECE 3 DRILL HINGE A4 SLIMLINE	T104B	175(180*)mm X 320mm	Multiple X A4 trimmed

* When copysafe sleeves are used with the menu, an extra 5mm is added to the width.

* Code:T103C - TWO PIECE INVERTED HINGE A4 / T104C - TWO PIECE INVERTED HINGE A4 SLIMLINE

STYLE 6

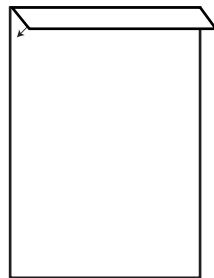
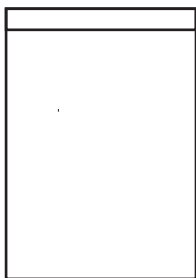

T130

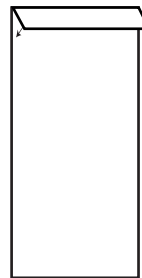
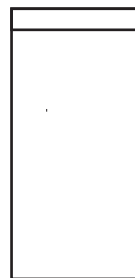

T131

DESCRIPTION	CODE	SIZE (W X H)	PAPER INSERT
MAGNETIC A4 BOARD	T130	225mm x 310mm	Multiple x A4
MAGNETIC SLIM A4 BOARD	T131	120mm x 310mm	Multiple x A4 w100mm



the menu company

TECHNICAL SPECIFICATION SHEET FOR FABRIC MENUS

Updated: April 2009

STYLE 7

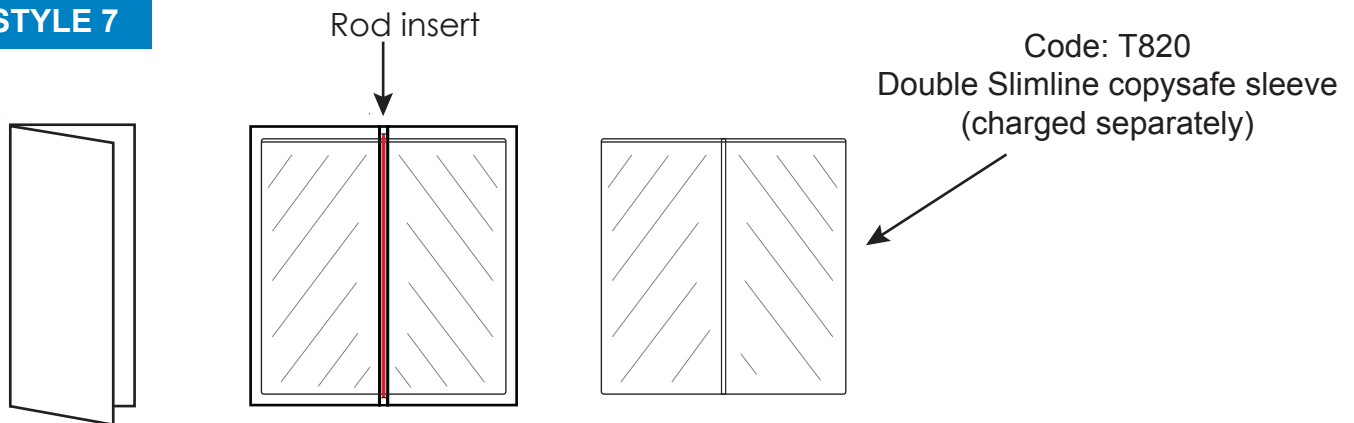

DESCRIPTION	CODE	SIZE (W X H)	PAPER INSERT
A4 SLIMLINE WITH ROD + SLEEVES	T120_Slim/A4	155mm x 335mm	140mm W x 297mm H
COCKTAIL WITH ROD + SLEEVES	T120_Ctail	120mm x 335mm	105mm x 297mm
SQUARE MENU WITH ROD + SLEEVES	T121_SQ	235mm x 240mm	210mm W x 210mm H
A4 MENU WITH ROD + SLEEVES	T121_A4	225mm x 335mm	A4
A5 MENU WITH ROD + SLEEVES	T121_A5	180mm x 240mm	A5

STYLE 8

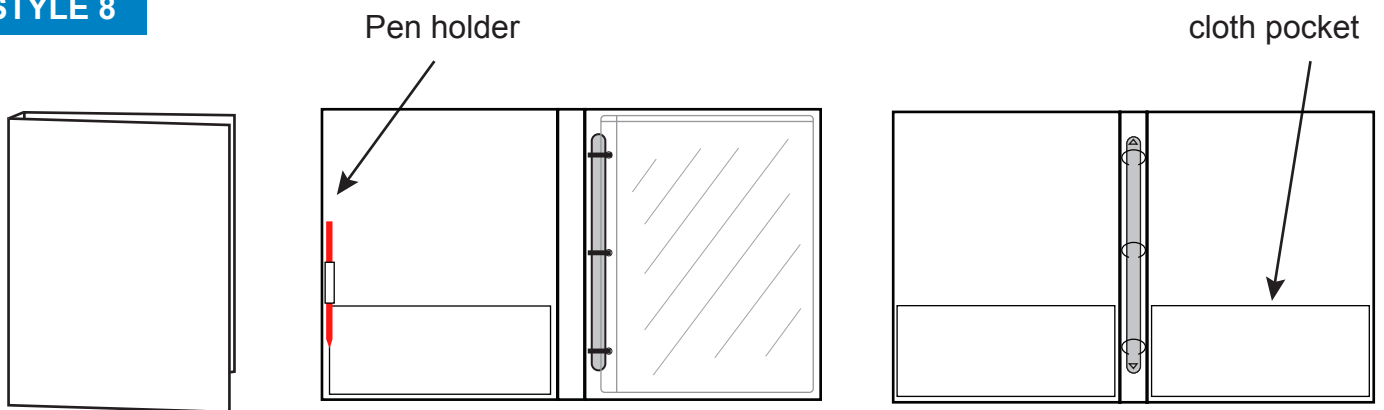

DESCRIPTION	CODE	SIZE (W X H)	PAPER INSERT
A4 IN ROOM FOLDER - 3 D'RING	T122A	245(260*)mm X 320mm	Multiple X A4
A4 IN ROOM FOLDER - 3 O'RING	T122B	240(255*)mm X 320mm	Multiple X A4
SQUARE FOLDER - 2 D'RING	T122C	240mm X 240mm	Multiple X A4 trimmed
SQUARE FOLDER - 2 O'RING	T122D	240mm X 240mm	Multiple X A4 trimmed

* When copysafe sleeves are used with the menu, an extra 5mm is added to the width.

* Additional features of horizontal pockets / pen holder



the menu company

TECHNICAL SPECIFICATION SHEET FOR FABRIC MENUS

Updated : April 2009

STYLE 9

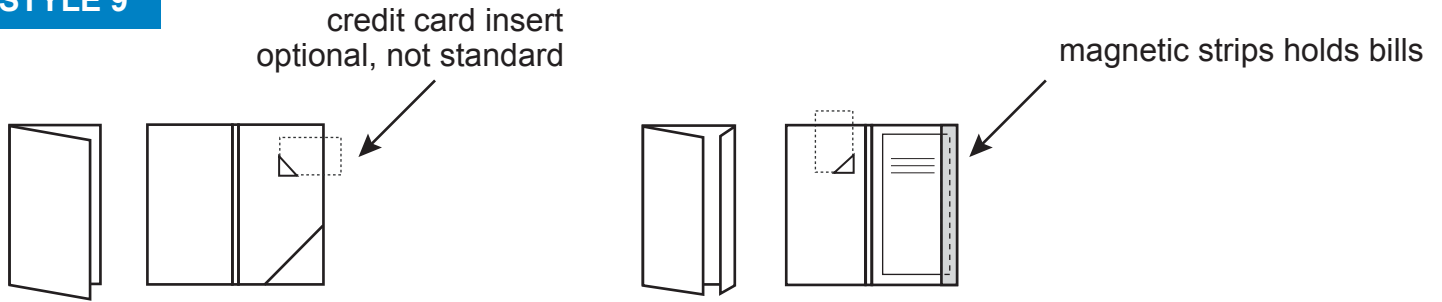

DESCRIPTION	CODE	SIZE (W X H)	PAPER INSERT
BILL FOLD WITH CREDIT CARD	T123	125mm x 235mm	DL (100mmx210mm)
BILL FOLD WITH MAGNETIC STRIP	T123B	125mm x 235mm	DL (100mmx210mm)

* Increase spine width to hold customised pen

HOTEL IN ROOM PRODUCTS

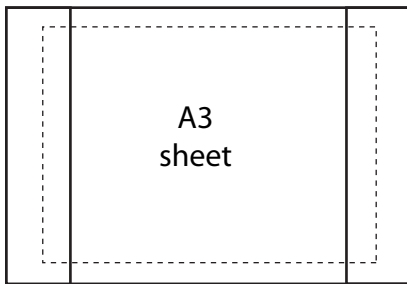

* **Desk Blotter** (Code:T128)
Side Flaps Optional

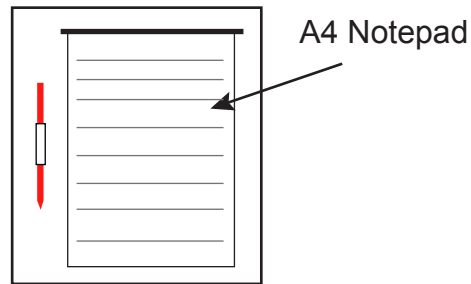

* **Note & Pen Holder** (Code:T125)

ADDITIONAL FEATURES

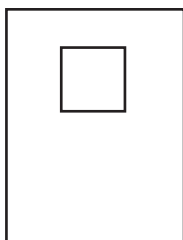

* **Cover with Die-cut window**



* **Foxy-digital print with Cloth Spine Wrap**